



HECKLER & KOCH

NO COMPROMISE

P30

CO₂

cal. .177 (4.5 mm)

pellet (360 fps)

cal. .177 (4.5 mm)

BB (395 fps)

powered by **UMAREX** www.umarex.com

UMAREX HOLDS THE WORLDWIDE EXCLUSIVE HK-TRADEMARK AND EXTERIOR DESIGN COPY LICENSE FOR USE WITH THIS UMAREX PRODUCT, GRANTED BY HK, INC., U.S.A.

EN Operating instructions

FR Mode d'emploi

ES Manual de instrucciones



WARNING:

NOT A TOY. ADULT SUPERVISION REQUIRED. MISUSE OR CARELESS USE MAY CAUSE SERIOUS INJURY OR DEATH. MAY BE DANGEROUS UP TO 300 YARDS (274 METERS).

2252302 | 07/09 © 2009



Description
Designation
Designacion



Operation
Emploi
Reglaje



Care
Entretien
Cuidados



Safety instructions
Instructions de sécurité
Instrucciones de seguridad



**EN****CAUTION | ATTENTION | ATENCIÓN**

Please read this owner's manual completely. This air gun is not a toy. Treat it with the same respect you would a firearm. Always carefully follow the safety instructions found in this owner's manual and keep this manual in a safe place for future use.

If you have any questions regarding your new air gun, please contact Umarex USA Customer Service at: Umarex USA Inc. | 6007 South 29th Street | Fort Smith, AR 72908 USA

Phone: (479) 646 - 4210 | Fax: (479) 646 - 4206 | www.UmarexUSA.com

Veillez lire entièrement le présent mode d'emploi. Cette carabine à air comprimé n'est pas un jouet. Utilisez-la comme s'il s'agissait d'une arme à feu. Suivez toujours attentivement les instructions de sécurité indiquées dans le mode d'emploi et gardez ce mode d'emploi dans un lieu sûr pour l'usage futur.

Pour toute question concernant votre nouvelle carabine à air comprimé, veuillez contacter le service Clientèle d'Umarex USA à l'adresse suivante :

Umarex USA Inc. | 6007 South 29th Street | Fort Smith, AR 72908 USA

Phone: (479) 646 - 4210 | Fax: (479) 646 - 4206 | www.UmarexUSA.com

Rogamos lea todo el manual de instrucciones. Esta carabina de aire comprimado no es un juguete, por lo que debe tratarla con el mismo respeto que si fuera un arma de fuego. Siempre deberá observar las instrucciones de seguridad que se detallan en el manual de instrucciones, guardando éste último en un lugar seguro para su utilización futura.

Si tuviera cualquier duda en relación con su nueva carabina de aire comprimado, rogamos se ponga en contacto con el servicio de atención al cliente de Umarex USA bajo: Umarex USA Inc. | 6007 South 29th Street | Fort Smith, AR 72908 USA

Phone: (479) 646 - 4210 | Fax: (479) 646 - 4206 | www.UmarexUSA.com



1.1 | H&K P30

EN

⚠ WARNING: NOT A TOY. ADULT SUPERVISION REQUIRED. MISUSE OR CARELESS USE MAY CAUSE SERIOUS INJURY OR DEATH. MAY BE DANGEROUS UP TO 300 YARDS (274 METERS).

YOU AND OTHERS WITH YOU SHOULD ALWAYS WEAR SHOOTING GLASSES TO PROTECT YOUR EYES. NORMAL READING GLASSES ARE NOT SHOOTING GLASSES. READ ALL INSTRUCTIONS BEFORE USING. BUYER AND USER HAVE THE DUTY TO OBEY ALL LAWS REGARDING THE USE AND OWNERSHIP OF THIS AIRGUN.

THIS AIRGUN IS INTENDED FOR USE BY THOSE 16 YEARS OF AGE OR OLDER.

⚠ WARNING: Lead pellets. Do not inhale dust or put pellets in mouth. Wash hands after handling. This product contains lead, a chemical known to the State of California to cause cancer and birth defects (or other reproductive harm.)

⚠ WARNING: Never leave a loaded gun unattended! Always store your gun unloaded. Engage the safety and make sure the magazine is empty. Keep your gun out of reach of children and persons who aren't familiar with it. Store pellets and 12 g CO₂ capsules in a separate location in order to prevent use by unskilled or unauthorized persons.

⚠ WARNING: Do not brandish or display this airgun in public – it may confuse people and may be a crime. Police and others may think it is a firearm. Do not change the coloration and markings to make it look more like a firearm. That is dangerous and may be a crime.

1.2 THE PARTS OF YOUR NEW CO₂ AIRGUN

EN



1 Muzzle

2 Front sight

3 Rear sight

4 Slide

5 Slide release lever

6 Safety

7 Hammer

8 Decocking key

9 Magazine

10 Magazine release

11 Trigger

1.3 THE PARTS OF YOUR NEW CO₂ AIRGUN

EN



- 1 Follower
- 2 Loading port for BBs
- 3 Capsule screw
- 4 Charging screw
- 5 Follower lock



Loading Aid



BB-Adapter

If you learn the names of the parts of your airgun, you'll find it easier to understand these instructions. Read the manual carefully to get the most out of your new airgun.

2.1 | USING THE SAFETY

EN

To lock the safety (put "ON SAFE"), press it in as shown in Fig. 2.a until it engages (red marking is not visible).

To release the safety (put "OFF SAFE"), press it as shown in Fig. 2.b until it clicks out. The red marking is now visible (see Fig. 2.c) and the airgun is ready to fire.

⚠ WARNING: When handling any airgun, make sure that the safety is engaged. Always point the muzzle in a safe direction.

ATTENTION: Make it a habit to keep the airgun uncocked and on safe until you intend to shoot.



To lock the safety (put "ON SAFE"), press it in as shown in Fig. 2.a until it engages (red marking is not visible).



To release the safety (put "OFF SAFE"), press it as shown in Fig. 2.b until it clicks out. The red marking is now visible (see Fig. 2.c) and the airgun is ready to fire.

2.2 INSERTION AND CHANGE CO₂-CAPSULE EN

⚠ WARNING: Keep your face and hands a safe distance from the opening of the 12 g CO₂ capsule. Escaping residual CO₂ can cause freezing of skin.

⚠ WARNING: Do not place your hand or fingers over the muzzle. Always make sure your air gun is pointing in a SAFE DIRECTION, and keep your finger away from the trigger. Failure to follow these warnings may cause serious injury or death.



- 1 Press magazine release
- 2 Remove the magazine



- 1 Turn capsule screw downwards.
- 2 Turn charging screw in the OPEN direction (marked on the bottom of knob).



Insert capsule.



- 1 Fix capsule in place with capsule screw.
- 2 Turn cartridge screw in POWER direction.



Push magazine into airgun.

2.3 INSERTION AND CHANGE CO₂-CAPSULE EN

⚠ WARNING: Never try to use force when inserting a 12 g CO₂ capsule.

⚠ WARNING: 12 g CO₂ capsules can explode at temperatures above 50° C (122° F). Do not expose them to heat or store them at temperatures above 50° C (122° F). Never try to use a spent capsule for any other purpose. Never leave 12 g CO₂ capsules in direct sunlight.

2.4 LOADING

⚠ WARNING: The HK P30 can shoot .177 (4.5 mm) cal. steel BBs or pellets. Never try to shoot with both projectiles at once!

NOTE: THE PROPER PROJECTILE AND CALIBER ARE MARKED ON THE AIRGUN.

2.5 LOADING STEEL BBs

ATTENTION: Use only .177 (4.5 mm) cal. steel BBs.



NOTE:

Only use flawless BBs: Never use the following BBs: ❶ with edges, ❷ both halves not aligned, ❸ used, soiled.

Warranty expires if non-recommended BBs are used.

It's recommended to use precision BBs from RWS/UMAREX.

2.5 LOADING STEEL BBS

EN

ATTENTION: Frequent shooting with BBs wears down the grooves and lands in the barrel. This reduces accuracy when shooting with pellets.



- 1 Press magazine release.
- 2 Remove magazine.

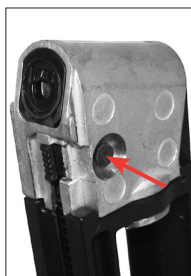

Push follower lock to the left to release follower.



Pull follower down and hold it there.
Load BBs.



Press release lever.
Slide opens automatically.



Insert BB adapter.



Close slide.

2.6 LOADING PELLETS

EN

⚠ WARNING: Remove all BBs before loading pellets. Use only .177 (4.5 mm) cal. pellets with a maximum length of 6.5 mm. Avoid using pointed pellets.

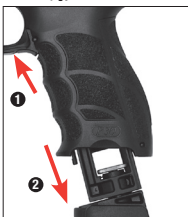

- 1 Press magazine release.
- 2 Remove magazine.



Pull follower down.
Remove all BBs.

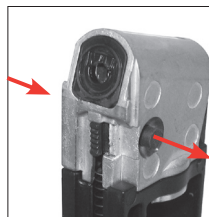

Push follower lock to the left (muzzle direction), allow the follow to go all the way, then push lock to the left to lock follower in place.

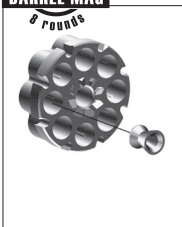

Load pellets into cylinder magazine.



Press the pellets into the rotary magazine using the loading aid.



Make sure pellets are positioned correctly.

⚠ WARNING: Do not pull the trigger while the airgun is being loaded. Keep your finger off the trigger! Never put your hand over the muzzle! Make sure the muzzle is always pointing in a safe direction. Never point the airgun at people or pets.



2.6 LOADING PELLETS

EN



Press release lever.
Slide opens automatically.

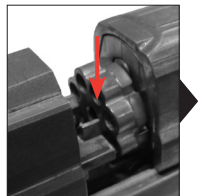

Insert rotary magazine
(gears to the rear).



Close slide.

⚠ WARNING: Always point the muzzle in a safe direction. Never aim at people or pets. Always handle the airgun as if it were loaded and ready to fire.

2.7 SIGHTS - CORRECT AIMING

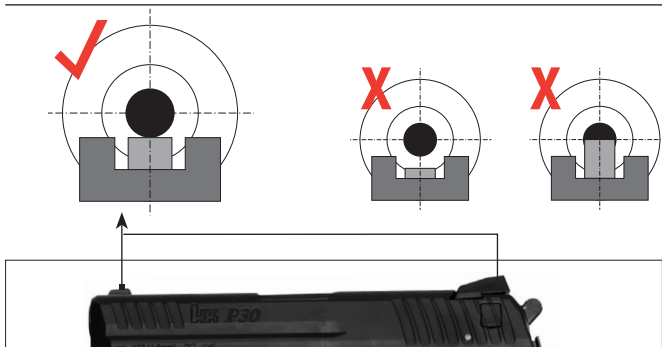

2.8 ADJUSTING THE SIGHT

EN



Loosen screw.
Move sight sideways.
Tighten screw.

2.9 SHOOTING

Make sure that the safety is "ON SAFE" (see section 2.1 "USING THE SAFETY"). Insert a 12 g CO₂ capsule and load the airgun as described in this manual.

After loading the airgun as described, make sure that the target, backstop and surroundings are safe. Put the safety on fire "OFF SAFE". The airgun is now ready to shoot. Squeeze the trigger gently but steadily until a shot is released. The airgun will reload automatically after each shot and will be ready to fire again.

NOTE:

- If the CO₂ pressure is too low, the magazine will not advance, preventing further shooting.
- Shooting without a pellet releases more CO₂ than shooting with one.

⚠ WARNING: Always point the muzzle in a safe direction. Never aim at people or pets. Always handle the airgun as if it were loaded and ready to fire.

2.9 | SHOOTING

EN

⚠ WARNING: This is a high-powered airgun, which means you must be especially careful when selecting a target. Choose only targets that cannot be penetrated and whose hard surfaces will not cause pellets to ricochet. Never shoot at water!



Put the safety on FIRE position.



Pull trigger.

2.9 | SHOOTING

EN



- 1 Cock hammer.
- 2 Pull trigger.

- Do not shoot at hard surfaces or at the surface of water. The projectile may bounce off or ricochet and hit someone or something you had not intended to hit.
- Always choose your target carefully. It is best to shoot at paper bullseye targets, which are attached to a safe backstop. A heavy blanket should be hung behind the target trap to prevent ricochet should you miss the backstop.
- Your backstop should be checked for wear before and after each use. Replace your backstop if the surface is worn or damaged, or if a ricochet occurs.
- Your air pistol is designed for target shooting and is suited for both indoor and outdoor use. Always remember to place your target carefully. **THINK** about what you will hit if you miss the target.

2.10 | DECOCK



Press decocking key. The airgun is decocked. It cannot discharge accidentally.

2.11



FEED JAM

EN

⚠ WARNING: Feed jams are dangerous!

**WHENEVER THERE IS A FEED JAM, ENGAGE THE SAFETY (PUT "ON SAFE")!
MAKE SURE THAT THE MUZZLE IS POINTING IN A SAFE DIRECTION.**

A feed jam can have various causes:

1. A projectile is lodged in the barrel

Engage the safety (put "ON SAFE"), remove the magazine and push the projectile out of the barrel using a cleaning brush (cleaning rod).

2. A projectile is lodged between the magazine and the barrel

Decock the airgun and engage the safety (put "ON SAFE"). Remove the magazine by pulling it down forcefully while pressing the magazine release. Point the airgun in a safe direction and shoot a few times without the magazine. This should release the projectile. If the airgun remains jammed, push the projectile back through the muzzle using a cleaning brush. Check to make sure the projectiles are loaded correctly in the magazine. Reload your airgun as described in 2.4 through 2.6.

⚠ WARNING: If the airgun does not fire, do not assume that the magazine is empty.

2.12



FEED JAM

EN



Engage the safety.



Press release lever.
Slide opens automatically.

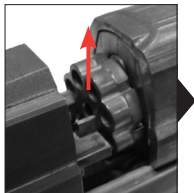

Remove rotary
magazine.



Press magazine release.
Remove magazine.



If a projectile becomes lodged in the barrel or if BBs jam the magazine:
push it out with a cleaning brush.





2.12 SPECIAL FACTORS RELATED TO CO₂

Sometimes the performance of a CO₂-powered air gun is adversely affected by special factors. An example is when the airgun is used, kept or stored at temperatures well above or below the normal outdoor temperatures (15-21° C; 59-70° F).

High temperatures can create a pressure in the 12 g CO₂ capsule and the airgun itself which considerably exceeds the normal operating pressure. Such overpressure can prevent the release of a shot and cause permanent damage. This airgun should not be stored or used at temperatures above 50° C (122° F).

Do not use the airgun with a 12 g CO₂ capsule that has already lost a lot of pressure.

Signs of insufficient pressure in a capsule include the following:

- 
- A) The rotary magazine does not advance (there is no shot).
 - B) The shot is not as loud as with a full capsule.
 - C) The projectiles hit the target lower than they do when the capsule is full (they have a lower velocity).
- 

 **WARNING:** if the gun is fired with insufficient CO₂ pressure, a projectile might become lodged in the barrel.

2.13 REMOVING A CO2 CYLINDER

EN



Put "ON SAFE" – NO RED SHOWING (See section 2.1).



With the muzzle pointed in a safe direction, remove the magazine.



Slowly turn the charging screw clockwise (toward "power") allowing any remaining gas to be discharged and continue turning screw until it stops.



Loosen capsule screw. Remove and properly dispose of CO2 capsule.

3



CARE

EN

- Before you attempt to perform maintenance on your airgun, make sure the airgun is "ON SAFE" and unloaded, and the CO2 capsule has been removed.
- Perform routine inspections of the airgun to check for proper function.

ATTENTION:

Frequent shooting with BBs wears down the grooves and lands in the barrel. This reduces accuracy when shooting with pellets.



Oil the magazine slot to prevent jamming of BBs.

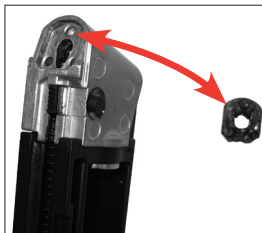

If the rubber lip on the valve is worn, the gun might shoot two BBs at once. To remedy this, remove the rubber lip and use a little instant glue to affix the spare part supplied.

If you take good care of your airgun and handle it properly, it will give you years of pleasure. To keep your gun working properly place two drops of RWS Chamber Lube or other airgun oil on the valve. Shooting will spread the oil through the gun mechanism.

- Your airgun will maintain proper function for a long time if you oil the slide rails with 1 drop of RWS Spring Cylinder Oil or other airgun oil after you have fired approximately 250 shots. DO NOT use a petroleum distillate based oil or solvent and DO NOT over-oil because this can cause damage to your air pistol.
- Apply 1 to 2 drops of RWS Spring Cylinder Oil onto all other moving parts such as the trigger hinge and threads of the gas capsule charging screw.

ATTENTION:

Tampering with the airgun or attempts to change the airgun in any way may make it unsafe to use and will void the warranty.

CAUTION:

If you drop your airgun, check to see that it works properly before you use it again. If anything seems changed, like a shorter or weaker trigger pull, this may mean worn out or broken parts. Call Customer Service at Umarex USA for assistance before using your airgun again.

4.1 | PROBLEM SHOOTING

EN

| Problems | Possible causes | | | | | | | | | | | |
|--------------------------------|------------------|-------------------------------|---|--------------------------------------|----------------------|------------------|-------------------------|---|------------------|-----------------------------|-------------------------------------|--------------------------------|
| | Safely activated | CO ₂ capsule empty | Follower not locked when shooting pellets | CO ₂ capsule not inserted | Extreme temperatures | Wrong ammunition | Ammunition badly loaded | BBs and pellets loaded at the same time | Slide not closed | Sight not properly adjusted | BBs are jammed in the magazine slot | Rubber lip in magazine is worn |
| Faulty shooting direction | | ● | ● | | ● | ● | ● | ● | | ● | | |
| Airgun does not shoot | ● | ● | | ● | | ● | ● | ● | ● | | ● | |
| Low velocity | | ● | ● | | ● | ● | ● | | | | | |
| The airgun always shoots 2 BBs | | | | | | | | | | | | ● |

MODIFYING THE AIRGUN

⚠ WARNING: The components of this air rifle have been designed and manufactured to ensure optimal function and performance at all times. Any changes in design or performance can impair the function and make the airgun unsafe. Unauthorized modifications of any kind will void the warranty.

REPAIR SERVICE

Do not return defective or damaged product to the dealer. If your airgun needs repair, call Umarex USA (479) 646-4210 and ask for the Service Department or visit www.UmarexUSA.com. DO NOT ATTEMPT TO DISASSEMBLE IT! Your airgun requires special tools and fixtures to repair it. Any disassembly or modification not performed by Umarex USA will void the warranty.



4.2 | WARRANTY

EN

LIMITED ONE YEAR WARRANTY

This product is warranted to the retail consumer for 1 year from date of purchase against defects in material and workmanship and is not transferable.

WHAT IS COVERED

Replacement parts and labor.

WHAT IS NOT COVERED

Shipping charges to Umarex USA for defective product and damages caused by abuse or failure to perform normal maintenance as well as any other expense. Consequential damages, or incidental expenses, including damage to property. Some states do not allow the exclusion or limitation of incidental or consequential damages, so the above limitation or exclusion may not apply to you.

WARRANTY CLAIMS

Warranty Claims and Repair for U.S. and Canadian customers only.

Call Umarex USA (479)-646-4210 and ask for the Service Department. If it is determined a return is necessary, you will be issued a Return Authorization Number. Write this number boldly on the box and return the product prepaid to Umarex USA. Your name, address, phone number and a note explaining the defect found must be included in the package. A copy of the original purchase receipt must accompany the return. Include a check made to Umarex USA in the amount of \$14.95 to cover shipping and handling.

IMPLIED WARRANTIES

Any implied warranties, including the implied warranties of merchantability and fitness for a particular purpose, are limited in duration to 1 year from date of retail purchase. SOME STATES DO NOT ALLOW LIMITATIONS ON HOW LONG AN IMPLIED WARRANTY LASTS, SO THE ABOVE LIMITATIONS MAY NOT APPLY TO YOU. TO THE EXTENT ANY PROVISION OF THIS WARRANTY IS PROHIBITED BY FEDERAL STATE, OR MUNICIPAL LAW WHICH CANNOT BE PREEMPTED, IT SHALL NOT BE APPLICABLE. THIS WARRANTY GIVES YOU SPECIFIC LEGAL RIGHTS, AND YOU MAY ALSO HAVE OTHER RIGHTS WHICH VARY FROM STATE TO STATE AND COUNTRY TO COUNTRY.



4.3 | SAFETY INSTRUCTIONS

EN

SAFE HANDLING OF AIRGUNS

Learn how to handle your airgun in a safe and proper manner. Your new airgun shoots projectiles at a very high velocity, meaning that you must exercise special care. Remember that according to the basic rules of safety, touching any gun is the same as handling it.

- Put the safety on fire ("OFF SAFE") only when you intend to shoot, and re-engage the safety (put "ON SAFE") as soon as you are finished.
- Always handle any gun as if it were loaded.
- Before loading, always engage the safety to prevent inadvertent firing. Keep your finger out of the trigger guard and put it on the trigger only when you are ready to shoot.
- Use only ammunition that has been approved for this airgun, and use only 12 g CO₂ capsules.
- Always point the muzzle in a safe direction.
- Never transport a loaded gun. Load a gun only when you intend to fire it.
- Never point a gun at people or pets. Avoid ricocheting. Never shoot at smooth, hard surfaces or at water.
- Before shooting, make sure that the target and surroundings are safe.
- When you transport a gun or accept one from another person, always make sure that the safety is on and that it is unloaded.
- Make sure you can control the direction of the muzzle if you stumble or fall.
- Wear approved safety glasses when shooting.
- Always store your gun unloaded, with the safety engaged. Keep it out of reach of unauthorized persons (untrained persons, children, persons under 18). Store ammunition and CO₂ capsules separately.
- Give this gun only to persons over 18 who are thoroughly familiar with its use, and include the instruction manual.
- Modifications or repairs should be made only by Umarex USA.
- Never leave a loaded gun unattended.
- Unload your gun before giving it to someone else.

4.4 | TECHNICAL DATA

EN

TECHNICAL DATA



| | | | |
|---------------|---------------------------------|---------------------------|-------------------------------------|
| System: | CO ₂ pistol | Barrel length: | 85 mm / 3.35 in. |
| Trigger: | Single Action, Double Action | Weight: | 770 g / 1.7 lbs. |
| Ammo: | pellets, steel BBs | Magazine capacity: | BBs - 15 shots Pellets - 8 shots |
| Sights: | fixed front, adjustable rear | Safety: | manual |
| Caliber/Ammo: | cal. 4,5 mm / .177 | Dangerous range up to: | 275 meters / 300 yards |
| Length: | 180 mm / 7 in. | Power source: | 12 g CO ₂ capsule |
| | | Velocity: | up to 120 m/s / 395 fps |



WARNING:

The airguns manufactured by the company UMAREX Sportwaffen GmbH & Co. KG are made according to the German weapons legislation and the authorities in charge (PTB) are notified accordingly. We will not assume any liability whatsoever if our products are exported to territories outside of Germany and as a consequence do not comply with domestic legal requirements of these territories. It will be the sole responsibility of the importer to ensure compliance with local laws and regulations.



Distributed by / Distribué par:
UMAREXUSA®
www.UmarexUSA.com

6007 South 29th Street
Fort Smith, AR 72908
Phone: 479-646-4210

We reserve the right to make color and design changes and technical improvements. No responsibility is accepted for printing errors or incorrect information.

Sous réserve de modifications de couleur et de design, de modifications techniques, d'erreurs d'impression et d'erreurs en général. Informations sous toutes réserves.

Sujeto a cambios de color y diseño así como a mejoras técnicas y errores de impresión. Todos los datos sin garantía.

July 2009
© UMAREX USA

8-402-80.10