

PERFORMANCE

Many factors affect velocity, including brand of projectile and weight of projectile.

Your Marauder has been designed for quiet shooting. However when using light weight pellets the sound barrier may be broken resulting in a loud muzzle report.



DO NOT RETURN THIS PRODUCT TO THE STORE.

Our friendly customer service representatives will be glad to help. You can get answers to frequently asked questions at www.crosman.com or you can contact us directly at 1-800-7AIRGUN (1-800-724-7486)

REPAIR SERVICE

If your airgun needs repair, we recommend you take or send it to your nearest Crosman Authorized Service Station. DO NOT ATTEMPT TO DISASSEMBLE IT! Your airgun requires special tools and fixtures to repair it. Any disassembly or modification not performed by an Authorized Service Station will void the warranty.

A SPECIAL CUSTOMER SERVICE

Crosman Authorized Service Stations will unjam your airgun at no cost during the warranty period.

LIMITED ONE YEAR WARRANTY

This product is warranted to the retail consumer for one year from date of retail purchase against defects in material and workmanship and is transferable. To register the serial number of your airgun, please return the airgun registration form. The warranty is not conditioned on the return of the card. You should retain the original sales receipt as record of date of purchase.

WHAT IS COVERED

Replacement parts and labor. Transportation charges to consumer for repaired product.

WHAT IS NOT COVERED

Transportation charges to Authorized Service Station for defective product. Damages caused by abuse, modification or failure to perform normal maintenance – see Owner's Manual. Any other expense. CONSEQUENTIAL DAMAGES, INCIDENTAL DAMAGES, OR INCIDENTAL EXPENSES INCLUDING DAMAGE TO PROPERTY. SOME STATES DO NOT ALLOW THE EXCLUSION OR LIMITATION OF INCIDENTAL OR CONSEQUENTIAL DAMAGES SO THE ABOVE LIMITATION OR EXCLUSION MAY NOT APPLY TO YOU.

HOW TO OBTAIN WARRANTY PERFORMANCE

U.S. Customers- Locate nearest service station (see www.Crosman.com or call Crosman customer service at 800-724-7486 for list of stations). The service station will give you details of how to proceed with sending the item in for repair. You must contact the station prior to shipping your product.

International Customers- Please return product to your nearest distributor. If you do not know your distributor, please call 585-657-6161 and ask for our International Department for assistance.

IMPLIED WARRANTIES

ANY IMPLIED WARRANTIES INCLUDING THE IMPLIED WARRANTIES OF MERCHANTABILITY AND FITNESS FOR A PARTICULAR PURPOSE ARE LIMITED IN DURATION TO ONE YEAR FROM DATE OF RETAIL PURCHASE. SOME STATES DO NOT ALLOW LIMITATIONS ON HOW LONG AN IMPLIED WARRANTY LASTS SO THE ABOVE LIMITATIONS MAY NOT APPLY TO YOU.

To the extent any provision of this warranty is prohibited by federal, state or municipal law, which cannot be preempted, it shall not be applicable. This warranty gives you specific legal rights and you may also have other rights, which vary, from state to state.

CROSMAN and Benjamin are registered trademarks of Crosman Corporation in the United States.

Crosman Corporation
7629 Rts. 5 & 20
East Bloomfield, NY 14443
800-7-AIRGUN
www.crosman.com

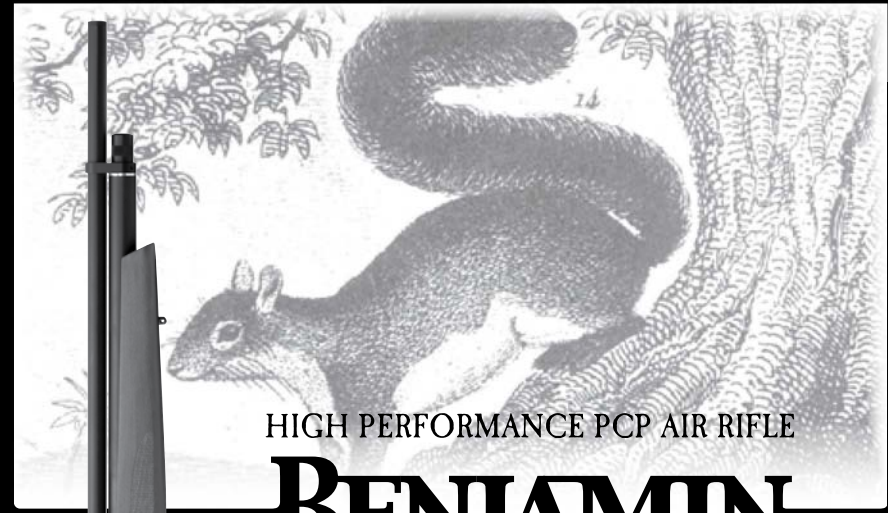

HIGH PERFORMANCE PCP AIR RIFLE

BENJAMIN

A Heritage of Performance since 1899



Marauder

Pre-Charged Pneumatic Airgun
BP1763 - .177 caliber Pellet Air Rifle
BP2263 - .22 caliber Pellet Air Rifle
OWNER'S MANUAL

**READ ALL INSTRUCTIONS AND WARNINGS IN
THIS MANUAL BEFORE USING THIS AIRGUN**

BP1763-515

⚠ WARNING: Not a toy. This airgun is recommended for adult use only. Misuse or careless use may cause serious injury or death. May be dangerous up to 600 yards (549 meters).

⚠ WARNING: Do not brandish or display this airgun in public—it may confuse people and may be a crime. Police and others may think it is a firearm. Do not change the coloration and markings to make it look more like a firearm. That is dangerous and may be a crime.

YOU AND OTHERS WITH YOU SHOULD ALWAYS WEAR SHOOTING GLASSES TO PROTECT YOUR EYES.
 READ ALL INSTRUCTIONS BEFORE USING.
 BUYER AND USER HAVE THE DUTY TO OBEY ALL LAWS ABOUT THE USE AND OWNERSHIP OF THIS AIRGUN.

THIS AIRGUN IS INTENDED FOR USE BY ADULTS ONLY

⚠ WARNING: Lead pellets. Do not inhale dust or put pellets in mouth. Wash hands after handling. This product contains lead, a chemical known to the State of California to cause cancer and birth defects (or other reproductive harm.)

⚠ WARNING: Use only compressed air in this airgun. When using Crosman's optional CO₂ adapter you may use CO₂. Use no other gasses—including oxygen, which can cause a fire or explosion that may result in serious injury or death.

Please read this owner's manual completely. And remember that an airgun is not a toy. Always carefully follow the safety instructions found in this owner's manual and keep the manual in a safe place for future use. If you have any questions regarding the operation of your new airgun, please contact Crosman at 1-800-724-7486.

1. Learning the Parts of your New Airgun
2. Operating the Safety
3. Pressurizing the Airgun
4. De-pressurizing
5. Loading the Airgun
6. Unloading and Un-Cocking the Airgun
7. Aiming and Firing Safely
8. Removing a Jammed Pellet
9. Maintaining your Airgun
10. Advanced Tuning Techniques
11. Reviewing Safety

⚠ WARNING: Because this airgun has an adjustable match grade trigger, it could fire when dropped or jarred, with or without the safety engaged.

Tools Needed If Following Advanced Tuning Techniques (not included)

- 1/4" Allen Wrench
- 1/8" Allen Wrench
- 5/64" Allen Wrench
- .050" Allen Wrench
- 3/16" Allen Wrench

1. Learning the Parts of your New Airgun

Learning the names and parts of your new airgun will help you understand your owner's manual. (Fig. 1)

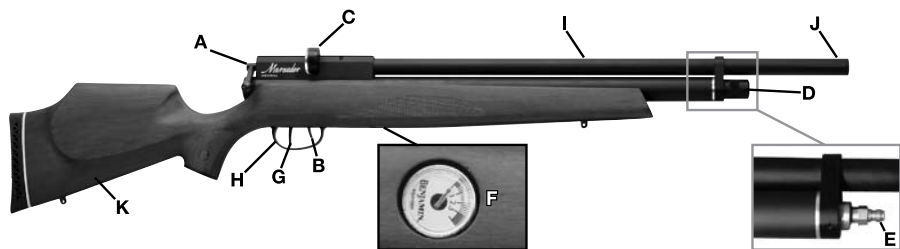

A. Bolt B. Safety C. Clip D. Protective Cap For Fill Nipple E. Fill Nipple F. Pressure Gauge G. Trigger H. Trigger Guard I. Barrel J. Muzzle K. Stock

Your new airgun is unique because it operates on either air or CO₂. To fill and shoot with CO₂, an optional CO₂ fill adapter must be purchased. This owner's manual describes operating the gun with air, only. The manual that comes with Crosman's CO₂ adapter describes operation on CO₂.

2. Operating the Safety

A. To Put the Airgun "ON SAFE:"

- Locate the safety in front of the trigger.
- The letters "F" (fire) and "S" (safe) on the bottom of the trigger guard also indicate the appropriate position of the safety (Fig 2A).
- Push the safety towards the trigger to put the safety on. The safety is on, and the airgun is "ON SAFE" when the lever is in the rear position (near the trigger). (Fig. 2B)



Even when the safety is on, you should continue to handle the airgun safely. Don't point the gun at anything you don't intend to shoot.

Like all mechanical devices, an airgun safety can fail. Even when the safety is "ON SAFE", you should continue to handle the airgun safely. NEVER point the airgun at any person. NEVER point the airgun at anything you do not intend to shoot



B. To Take the Airgun "OFF SAFE"

- Push the safety to the forward position (away from the trigger). When the airgun is "OFF SAFE" it is ready to be fired after following the instructions in this manual on how to fill and load. (Fig. 2C)



3. Pressurizing the Airgun

This airgun is designed for use at pressures between 2,000 and 3,000 psi depending on how you, as the user, adjust (tune) the gun to work.

⚠ WARNING: Use only compressed air in this airgun. When using Crosman's optional CO₂ adapter you may use CO₂. Use no other gasses—including oxygen, which can cause a fire or explosion that may result in serious injury or death.

A. Pressurizing (Filling) the Airgun with a Hand Pump

- Be sure to wear eye protection
 - Make sure the airgun is unloaded and not cocked. (See section 6 for instructions on unloading and un-cocking.)
 - Read all instructions with your hand pump so you are familiar with its operation. Use only a pump designed for filling a pre-charged airgun and outfitted with a Foster #12FS quick disconnect fitting. Do not use a standard air compressor or bicycle pump.
 - Put the airgun "ON SAFE" (see section 2A).
 - Point the airgun in a SAFE DIRECTION.
 - Remove the threaded cap that covers the fill nipple on the airgun by turning counter-clockwise.
 - Connect the quick-disconnect fitting on the hand pump hose to the fill nipple (fig. 3)
 - Make certain the bleed valve on the hand pump is fully closed (tighten in a clockwise direction) (fig.4).
 - Start pumping and continue until the gauge needles on your pump and on the airgun are between 2000 psi and 3000 psi depending on your desired tune.
- DO NOT fill the airgun to more than 3000 psi. See "Overfill" information section 3C.

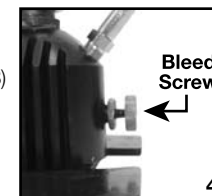
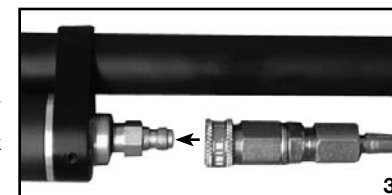

⚠ WARNING: Disconnecting the fill hose from the airgun without bleeding the air first may result in injury from hose whip as a result of pressure in the fill hose.

- Open the bleed screw on the pump base rapidly in a counter-clockwise direction to COMPLETELY bleed the hose. You must bleed the fill hose COMPLETELY to avoid hose whip from pressure in the fill hose.
- Disconnect the pump from the fill nipple on the gun
- Replace the cap over the fill nipple and tighten. Always keep the fill nipple capped to eliminate the possibility of dirt entering the check valve.

B. Pressurizing (Filling) the Airgun with a High Pressure Tank

The Marauder may be filled from a high pressure tank (bottle). Scuba tanks and other high pressure tanks can be outfitted for the task. Make certain that only clean, dry, compressed air is used in your filling apparatus. A reputable dive shop or paintball shop is best suited to fill and service tanks and bottles used for filling your PCP airgun.

- Be sure to wear eye protection
- Make sure the airgun is unloaded and not cocked. (See section 6 for instructions on unloading and un-cocking.)
- Read all instructions with your tank so you are familiar with its operation.
- Put the airgun "ON SAFE" (see section 2A).
- Point the airgun in a SAFE DIRECTION.
- Remove the cap that covers the fill nipple on the airgun.
- Connect the quick-disconnect fitting on the tank's hose to the fill nipple (fig. 3).
- Slowly open the valve on your tank and start filling the gun SLOWLY. Filling too quickly will cause heat buildup that can affect accuracy of the fill pressure.
- Watch the gauges on the airgun and your tank (if equipped) until the desired pressure is reached (2000-3000 psi)
- DO NOT fill the airgun to more than 3000 psi. See "Overfill" information in section 3C.
- Turn the valve on your tank off when the desired fill pressure is reached.
- BLEED the fill hose COMPLETELY to avoid hose whip from pressure in the fill hose
- Disconnect the tank's fill hose from the fill nipple on the airgun.
- Replace the cap over the fill nipple and tighten. Always keep the fill nipple capped to eliminate the possibility of dirt entering the check valve.

TIP: If your airgun is being filled from completely empty (zero pressure) the tension of the hammer pressing against the valve may keep the valve open which will cause air to leak down the barrel. This is most likely to happen with a gun tuned for a high fill pressures, where the hammer spring preload is adjusted to a high rate. In the event this occurs try cocking the bolt and leaving it in the rear (fully open) position to eliminate the force on the valve allowing it to close. Always make certain the airgun is not loaded and there is not a pellet in the chamber.

C. Overfill

- Over filling beyond the "as tuned" best fill pressure does not improve performance. It will actually lessen performance and may cause the valve to lock. For instance a gun tuned for best performance at 2,000 psi may partially valve lock at 3000 psi. If you discover that the airgun has been over filled, try to dry fire the airgun (cock and shoot with no pellet loaded) in a SAFE DIRECTION until pressure on your airgun drops to 3,000 psi or less depending on where your gun's tuned best fill pressure is.
- If the airgun will not discharge air with each shot, the valve may be completely pressure locked and will require use of the degassing tool included with your airgun. Follow the instructions included with the degassing tool to fully or partially depressurize the airgun.

4. Depressurizing the Airgun

Your Marauder airgun, like most PCP airguns, is best stored with some pressure in the reservoir. This keeps the seals in the airgun forced against the sealing surfaces. In the event you want or need to depressurize (e.g. for service) follow the following steps:

A. Dry Fire Method

- Keep the air rifle pointed in a SAFE DIRECTION.)
- Remove all the air from your air rifle by repeatedly cocking and dry-firing with the air rifle pointed in a SAFE DIRECTION until the pressure gauge on your airgun shows no pressure and air cannot be heard when the shot is fired.
- Put the air gun "ON SAFE".

B. Degassing Tool Method

- Make certain the airgun is not in the cocked position by:
 - Pointing the airgun in a SAFE DIRECTION.
 - Removing the clip.
 - Closing the airgun bolt by sliding forward and latching.
 - Pulling the trigger.
- Insert the degassing tool included with your Marauder airgun into the threaded plug as shown in Figure 5A.
- Turn the tool into the airgun in a clockwise direction until resistance is felt. This will indicate the nose of the tool has come in contact with the internal valve.

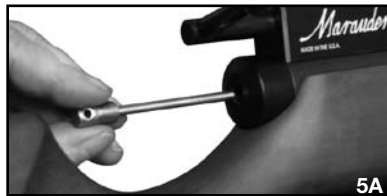

⚠ WARNING: Performing the following procedure will exhaust air from the barrel at a high rate. Make certain the airgun is pointed in a SAFE direction.

- Using an Allen wrench or screwdriver through the hole in the degassing tool (fig 5B) apply leverage to turn the tool and force the internal valve open. This may require approximately 1-2 complete turns to totally degas the airgun.
- Remove the degassing tool completely from the airgun. Leaving the tool in the airgun will interfere with the normal operation of the firing mechanism.

- Cock the airgun and dry-fire (no pellet) in a SAFE direction to make certain all pressure has been relieved from the airgun
- Check the gauge to make certain all pressure has been relieved from the airgun.

5. Loading the Airgun

⚠ WARNING: Use .177 caliber pellets only in your Model BP1763 and .22 caliber pellets only in your Model BP2263. Never reuse ammunition. Use of any other ammunition can cause injury to you or damage to the airgun.

A. Loading the Clip

- Lift the clear cover over the catch point and rotate in the direction of the arrows (clockwise) per Figure 6A. Turn until the cover appears as shown in Figure 6B.
- Place a finger under the clip covering the hole, place the first pellet in the clip, nose first (Fig. 6C). Make certain the pellet does not protrude out the back of the clip. In the event the pellet does protrude simply push the pellet inward.
- Rotate the cover counter clockwise and place the remaining pellets into the clip. Upon completion of filling the remaining positions rotate the cover until it comes to rest at the catch point as shown in figure 6D. The clip is now ready for use.

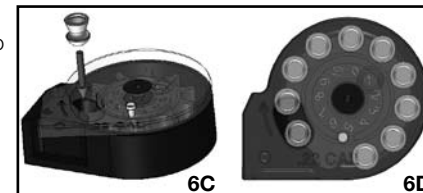
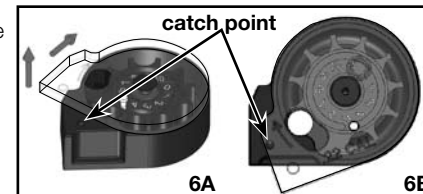

B. Inserting the Clip

NOTE: Following these directions will result in your gun being loaded and ready to fire.

- Put the air rifle "ON SAFE" (see section 2A) and point in a SAFE DIRECTION.
- Pull the bolt back to the cocked position.
- With the cover of the clip facing the butt of the air rifle insert the clip from the right side and push it inward until it snaps into place. (fig 7)
- Push the bolt forward fully and latch to chamber a pellet.
- The air rifle is now ready to fire.



6. Un-Loading and Un-Cocking

A. Unloading- Removing the Clip

- Put the air rifle "ON SAFE" (see section 2A) and point in a SAFE DIRECTION
- Push the clip out of the receiver from the left side.
- Refill the clip and re-insert for continued shooting.

B. Un-Cocking

In the event you are finished shooting, remove the clip as instructed and un-cock the air rifle by the following steps:

- Point the air rifle in a SAFE DIRECTION.
- Take the air rifle "OFF SAFE" (section 2B).
- Pull the bolt back to the rear position.
- While firmly holding the bolt in the rear position, pull the trigger.
- Continue to hold the trigger back while sliding the bolt forward to the latched position.
- Release the trigger.
- Put the air rifle on "ON SAFE" (see section 2A).
- The air rifle is now ready for storing.

7. Aiming and Firing Safely

- Always point your airgun in a SAFE DIRECTION.
- Follow the instructions for filling the air gun (sections 3A or 3B) and loading pellets (section 5A and 5B).
- You and others with you should always wear shooting glasses to protect your eyes.
- Do not shoot at hard surfaces or at the surface of water. The pellet may bounce off or ricochet and hit someone or something you had not intended to hit.
- Always choose your target carefully. It is best to shoot at paper bull's-eye targets which are attached to a safe backstop. A heavy blanket should be hung behind the backstop to prevent ricochet should you miss the backstop.
- Your airgun is designed for target shooting and is suited for both indoor and outdoor use. Always remember to place your target carefully. THINK about what you will hit if you miss the target.
- Before firing the airgun make certain there is sufficient pressure for proper operation. The gauge needle should be pointing to the area between 1000 and 3000 psi on the gauge.

8. Removing a Jammed Pellet

A jammed pellet is usually the result of trying to fire the airgun when the pressure is too low. Before firing the airgun make certain there is sufficient pressure for proper operation, by making sure the gauge needle is pointing to the area between 1000 and 3000 psi.

⚠ WARNING: In this procedure you will put a cleaning rod down the barrel of a charged airgun. It is extremely important that while you are doing this the airgun be "ON SAFE", the bolt remains in open position and that your finger be kept away from the trigger. Failure to follow this warning may result in serious injury or death.

- Point the airgun in a SAFE DIRECTION.
- Put the airgun "ON SAFE" (see section 2A.)
- Open the bolt by pushing the bolt handle up and pulling it all the way back until you hear two clicks.
- With the bolt in the rearward position insert a ramrod of the proper size into the barrel (start at the muzzle). (fig 8) The barrel could be damaged if the proper sized cleaning rod is not used.

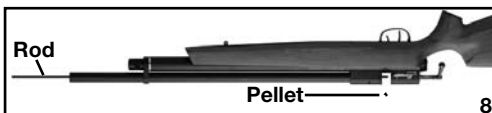

NOTE: The bolt must be cocked and open for the jammed pellet to clear the breech when it is pushed out by the ram rod.

- Using the ramrod push the pellet into the pellet loading port (forward of the bolt), remove and discard the pellet. Do not reuse that pellet.
- Point the airgun in a SAFE DIRECTION, close the action take "OFF SAFE" and fire.
- Put the airgun "ON SAFE" (see section 2A.)
- If you are not able to unjam your airgun by following this procedure, take no further action. Crosman Corporation or an Authorized Service Station will unjam your airgun. (no cost during the warranty period)

9. Maintaining Your Airgun

Apply Crosman silicone chamber oil (part number RMCOIL) on the barrel o-ring every 3 months or 500 shots. Apply with a cotton swab as shown in figure 9.

Apply a moly graphite EP grease to the sliding bolt mechanism every 3 months or 500 shots.

Keep all petroleum-based lubricants away from the fill nipple. They MUST NOT be introduced into the high pressure reservoir.



⚠ WARNING: Use of petroleum-based lubricants in this area could result in an explosion resulting in personal injury.

DO NOT MODIFY OR ALTER YOUR AIRGUN. Attempts to modify the airgun in any way inconsistent with this manual may make your airgun unsafe to use, cause serious injury or death, and will void the warranty. If you drop your airgun, visually check to see that it works properly before you use it again. If anything seems changed, like a shorter or weaker trigger pull, this may mean worn out or broken parts. Call Crosman customer service for assistance before using your airgun again.

⚠ WARNING: Do not attempt to repair the airgun or to disassemble to correct an over fill or valve lock. Parts can fly from the airgun at dangerous speeds when it is disassembled while pressurized.

10. Advanced Tuning Techniques

A. Adjusting the Trigger

The Marauder trigger assembly can be adjusted and customized but unless you are experienced in making such adjustments, Crosman recommends that these adjustments to factory settings be made only by a qualified gunsmith after reading all instructions. Adjusting the trigger assembly can result in a light trigger pull, decreased sear engagement that could make the gun more susceptible to discharge when dropped or jarred, or a non-functioning safety. Make only the adjustments identified in this manual.

NOTE: these adjustment features are for advanced shooters. Most shooters can use the settings provided during manufacturing of the gun and should not need to make modifications.

- The match grade trigger on your pellet air rifle is a two stage, fully adjustable unit. It has been factory set to an efficient setting that will suit most hunting and target uses. If you, as the owner, wish to alter the factory settings you should do so only after reading the following instructions carefully.
- Put the air rifle "ON SAFE", remove the clip and keep the airgun pointed in a SAFE DIRECTION. Depressurize the airgun (see section 4)
- Remove the stock screw (Fig 12) (using a 3/16" Allen wrench to separate the stock from the action.
- **Do not remove the trigger guard screws as the trigger guard should remain with the stock.**

⚠ WARNING: Adjustment of trigger screw (B) could inhibit proper function of the safety lever (F). Thus, always check for full engagement and smooth function of the safety lever upon completion of any changes to the trigger screw. If you are not sure if the safety is engaging and operating properly, take your gun to an experienced gunsmith.

⚠ WARNING: Adjustment to the trigger assembly could allow this airgun to fire if dropped or jarred, with or without the safety engaged.

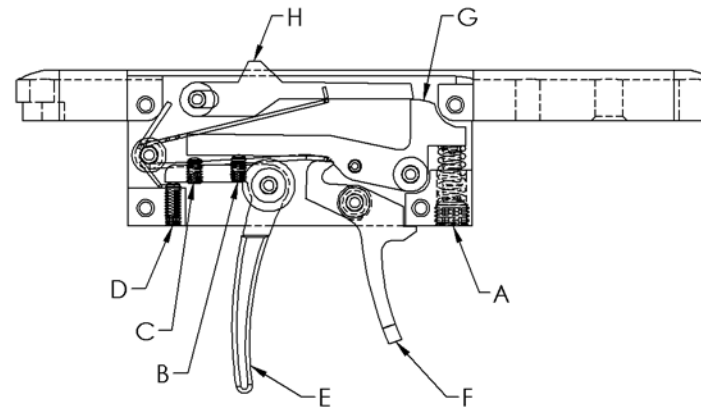

A. TRIGGER WEIGHT ADJUSTER B. FIRST STAGE ADJUSTER C. SECOND STAGE ADJUSTER D. TRIGGER POSITION E. TRIGGER F. SAFETY LEVER G. LINK H. SEAR

- **Trigger Pull** Using a 1/8" Allen wrench turn the adjuster screw (A) clockwise to increase trigger pull weight and counterclockwise to decrease trigger pull weight. This adjustment will not affect sear engagement.
 - **Trigger Position** Using a .050" Allen wrench the trigger position at rest can be adjusted. Turn screw (D) clockwise to move the trigger back and counter clockwise to move the trigger forward. This adjustment could affect sear engagement, and therefore could allow the gun to fire when dropped or jarred.
 - **Trigger Stages** Using a .050" Allen wrench for adjustment of screws (B) and (C), changes can be made to the position and length of first and second stages of the trigger motion. These adjustments could affect sear engagement, and therefore could allow the gun to fire when dropped or jarred.
 - Screw (B) changes the first stage. Turning screw (B) clockwise will increase the length of the first stage and decrease the sear engagement. Turning counter clockwise will decrease the length of the first stage and increase the sear engagement.
 - Screw (C) changes the second stage. Turning screw (C) clockwise will cause the second stage to occur sooner while turning counterclockwise will cause the second stage to occur later.
 - Adjustment of screws (B) and (C) should be done in harmony with each other as they work together to create the trigger's profile. Start slowly to understand what each adjustment does and its relationship to the other.
 - **Trigger Maintenance** The trigger is assembled with a moly graphite EP grease that should last for years. In the event your trigger becomes contaminated with debris and is not functioning properly, contact a qualified gunsmith to examine for repair or maintenance.
 - After adjusting your trigger, always check that the trigger and safety are functioning properly. If you are not sure if the trigger or safety is operating properly, take your gun to an experienced gunsmith.
 - Re-insert the action into the stock, and replace and tighten the stock screw.
- B. Adjusting for Various Fill Pressures**
- The Marauder is designed to be tuned to work at various fill pressures from 2000 psi (138 bar) up to 3000 psi (207 bar). This is done by adjustment of the hammer spring preload and hammer stroke length. In either case the adjustment changes the amount of energy the hammer generates when striking the valve. Higher fill pressure require more hammer energy while lower fill pressures require less hammer energy. **It is advised to always record your settings when tuning your airgun. (See Page 10)**
 - The Marauder has been factory set to an efficient fill pressure that will suit most hunting and target uses. If you, as the owner, wish to alter the factory settings you should do so only after reading the following instructions carefully.
 - Hammer Spring Pre-load adjuster
 - Put the air rifle "ON SAFE" (see section 2A), remove the clip and keep the airgun pointed in a SAFE DIRECTION. Remember that the airgun is pressurized and make only the adjustments identified in this manual.

To increase the energy, turn the hammer spring preload adjuster clockwise (fig 11A), up to 6 revolutions, using a 1/4" Allen wrench.

NOTE: More revolutions will simply cause the adjuster to spin but will not yield any higher force. Increasing the preload will be required to facilitate use of higher fill pressures.

The striker can be accessed through the hammer spring preload adjuster using a 1/8" Allen wrench (fig 11B). Turning the striker clockwise will shorten the hammer stroke and turning counter clockwise will lengthen the stroke. A long stroke length will yield higher hammer energy while a short stroke length will yield lower hammer energy. The striker can be adjusted inward by up to 12 revolutions.

A starting point for low fill pressures would start with a low hammer spring preload tension and a shorter hammer stroke.

A starting point for higher fill pressures will require more hammer spring preload tension and a longer hammer stroke. Refer to the chart below for suggested combinations of these adjustments based on fill pressures.



| Fill Pressure | Hammer Spring Preload | Hammer Stroke |
|---------------|---|--|
| Higher | Increase, turn adjuster in (Clockwise) | Increase. Turn Striker out (Counter Clockwise) |
| Lower | Decrease, turn Adjuster out (Counter Clockwise) | Decrease. Turn Striker in (Clockwise) |

TIP: Too little hammer energy at high fill pressures may result in very low velocities which is the result of partial valve lock. See the Overfill section (3C) to correct. Make only the adjustments identified in this manual. Do not attempt to adjust any other parts of a pressurized airgun, or make any repairs to a pressurized airgun.

Tuning the air rifle to obtain various velocity profiles can be achieved through the adjustment of the hammer spring and the striker and should be done in harmony with each other. Start slow to understand how each one affects the air rifle's performance. Experience and testing is the best way to understand these capabilities.

WARNING: Do not attempt to repair the airgun or to disassemble to correct an over fill or valve lock. Never repair a pressurized gun. Parts can fly from the airgun at dangerous speeds when it is disassembled while pressurized.

C. Tuning for Various Velocities

The Marauder air rifle has been factory set to an efficient velocity that will suit most hunting and target uses. If you, as the owner, wish to alter the factory settings you should do so only after reading the following instructions carefully. Unless you are experienced with working with airguns, Crosman Corporation suggests seeking the aid of a qualified gunsmith to perform these velocity adjustment procedures.

Put the air rifle "ON SAFE", remove the clip and keep the airgun pointed in a SAFE DIRECTION. Remember that the airgun is pressurized and make only the adjustments identified in this manual.

The Marauder may be tuned for various velocities by adjusting the valve metering screw. This will require removal of the stock. Remove the stock screw (Fig 12) (using a 3/16" Allen wrench to separate the stock from the action. Remember the action is pressurized. Keep it pointed in a safe direction.

Do not remove the trigger guard screws as the trigger guard should remain with the stock.

Using a 5/64" Allen wrench, remove the jam set screw first to allow access to the metering screw. (fig 13) (Be sure to stow the jam set screw in a safe place). Find the metering screw beneath the jam set screw previously removed. Using a 5/64" Allen wrench turn the metering screw clockwise to restrict the flow of air into the barrel and reduce the pellet velocity.



TIP: Turn the metering screw in all the way until it bottoms, counting how many turns it took to achieve the desired velocity. Record this value for future reference. 4 - 4 1/2 turns out from the bottomed position will completely clear the nose of the metering screw from the air path. Do not adjust the metering screw beyond this point. Though the metering screw will restrict air flow a great deal it will not completely shut off air flow. For use with CO₂ it is recommended to use a more open setting (metering screw out to clear air path)

Replace and tighten the jam screw. Re-insert the action into the stock, and replace and tighten the stock screw.

11. Reviewing Safety

- Never point the airgun at any person or at anything you do not intend to shoot.
- Always treat the airgun as though it is loaded and with the same respect you would a firearm.
- Always aim in a SAFE DIRECTION. Always keep the muzzle of the airgun pointed in a SAFE DIRECTION.
- Always keep the airgun on safe until you are ready to shoot.
- Always check to see if the airgun is "ON SAFE" (see section 2A) and unloaded when getting it from another person or from storage.
- Always keep your finger off the trigger and out of the trigger guard until ready to shoot.
- You and others with you should always wear shooting glasses to protect your eyes.
- If your reading or prescription glasses are not safety glasses, make sure you wear shooting glasses over your regular glasses.
- Use .177 caliber (4.5mm) pellets only in your Model BP1763 or use .22 caliber (5.5mm) pellet only in your Model BP2263. NEVER reuse ammunition.
- Do not shoot at hard surfaces or at the surface of water. The pellet may bounce off or ricochet and hit someone or something you had not intended to hit.
- Place the backstop in a location that will be safe should the backstop fail.
- Your backstop should be checked for wear before and after each use. All backstops are subject to wear and will eventually fail. Replace your backstop if the surface is worn or damaged or if a ricochet occurs.
- Do not attempt to disassemble or tamper with your airgun. Use an Authorized Service Station. Using unauthorized repair centers or modifying the function of your airgun in any way may be unsafe and will void your warranty.
- Store airgun in a secure location.
- Before you store your airgun, remove the clip, make sure there is no pellet in the chamber and make sure the gun is un-cocked (see section 6).
- Store this airgun charged with air or CO₂ to keep the valves closed against dirt.
- Whenever you store the airgun, make sure it is "ON SAFE" (see section 2A.)

This airgun has been classified as an adult airgun, and is recommended for adult use only. Because it is considered to be a special-purpose airgun, it is exempt from specific types of trigger pull, safety mechanism and drop tests.

SPECIFICATIONS

| | |
|---------------------------|--|
| Mechanism | Bolt Action |
| Capacity | 10 Shot Clip |
| Power source | Compressed Air Or Co ₂ (One Or The Other) |
| Caliber/Ammunition | Model BP1763 .177 Caliber Pellet Model BP2263 .22 Caliber Pellet |
| Weight | 7 Lb 8 Oz. |
| Length | 43 Inches |
| Barrel | Air Rifled Steel, Choked |
| Safety | Ambidextrous Lever |
| Velocity | Model BP1763 Adjustable Up To 1100 Fps Model BP2263 Adjustable Up To 1000 Fps |

