

AVANTI™

Daisy Outdoor Products

Rogers, AR 72757-0220 U.S.A.

800-643-3458

www.daisy.com

Part No. 136656-000
REV. 10/08

AVANTI™

Competition Pellet Rifle

Operation Manual



**AVANTI LEGEND
MODEL 853**



**AVANTI LEGEND EX
MODEL 853C**

Features a five-shot
clip with automatic indexing.

Use .177 cal. (4.5mm) LEAD AIRGUN PELLET 

⚠ WARNING: NOT A TOY. THESE AIRGUNS ARE DESIGNED FOR USE BY EXPERIENCED SHOOTERS AND ARE INTENDED FOR MATCH COMPETITION OR TARGET RANGE USE. MISUSE OR CARELESS USE MAY RESULT IN SERIOUS INJURY OR DEATH. MAY BE DANGEROUS WITHIN 257 YARDS (235 METERS).

THIS IS A SPECIAL CLASS OF NON-POWDERED GUN AND NOT FOR GENERAL USE. IT IS TO BE USED FOR TRAINING AND TARGET SHOOTING UNDER SUPERVISION. RECOMMENDED FOR USE BY THOSE 16 YEARS OF AGE OR OLDER. THIS GUN SHOOTS PELLETS ONLY. THE PURCHASER AND USER SHOULD CONFORM TO ALL LAWS GOVERNING THE USE AND OWNERSHIP OF AIRGUNS.

⚠ WARNING: THIS GUN CAN CAUSE DEATH IF CARELESSLY USED OR MISUSED. READ AND FOLLOW THE INSTRUCTIONS CAREFULLY. DO NOT LOAD A PELLET INTO THE CHAMBER UNTIL YOU ARE READY TO SHOOT. IF YOU DO LOAD A PELLET AND DECIDE NOT TO SHOOT, REMOVE EITHER MANUALLY OR BY SHOOTING IT IN A SAFE DIRECTION. AN UNCOCKED, UNLOADED GUN IS SAFEST. ACCIDENTS HAPPEN FAST, AND ACCIDENTALLY INJURING OR KILLING SOMEONE IS A TERRIBLE THING. PLEASE SHOOT SAFELY.

⚠ This safety alert symbol indicates important safety messages in this manual. When you see this symbol, be alert to the possibility of personal injury and carefully read the message that follows.

The Avanti Legend, model 853, and Avanti Legend EX, model 853C Competition Pellet Rifles shoot with much more muzzle energy than many BB and pellet guns. Use extreme caution when operating these guns. Although your new Avanti Competition Air Rifle is not a firearm, it has lethal potential and should be treated with the caution and respect due any conventional firearm. Like a firearm, your Avanti Competition Air Rifle, when misused or carelessly used, can kill or seriously injure the shooter or other persons. Always remember, the first and most important safety feature of any gun is the shooter. All safeties are mechanical devices and the shooter is the only part of the system that can make a gun safe—or unsafe. **DON'T DEPEND ON MECHANICAL SAFETIES** – think ahead and avoid situations that might lead to accidents.

Guns differ in their operation, and you are never ready to fire any gun until you are thoroughly familiar with it. Read the following operating instructions and, **WITHOUT LOADING ANY PELLETS**, proceed through the operating steps, dry firing your gun several times at a safe target. This will enable you to learn to operate this Avanti Competition Air Rifle properly and safely.

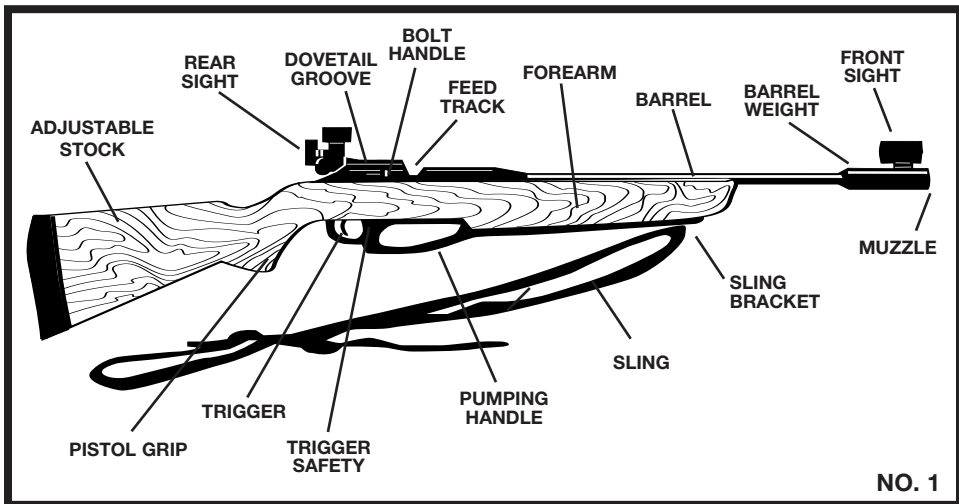

HOW TO OPERATE:

⚠ WARNING: Be sure gun is always pointed in a safe direction. Never point the gun at anyone. Always assume and handle the gun as if it were loaded and ready to fire.

- Step 1. OPEN BOLT
- Step 2. PUT “ON” TRIGGER SAFETY
- Step 3. PUMP ONCE
- Step 4. LOAD
- Step 5. CLOSE BOLT
- Step 6. AIM AT SAFE TARGET
- Step 7. TAKE “OFF” TRIGGER SAFETY
- Step 8. FIRE

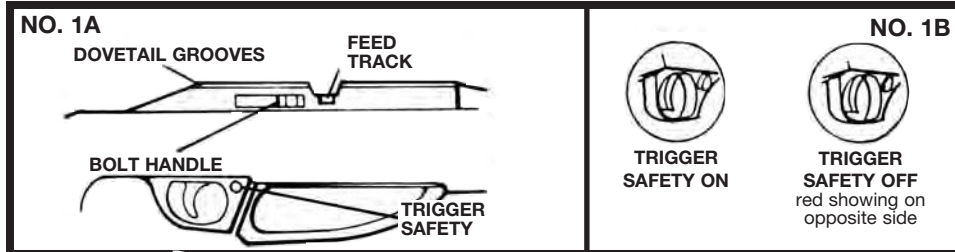

Step 1. OPEN BOLT

Pull the bolt handle fully to the rear. Then, release your hold on the bolt handle, leaving the bolt open. The gun cannot fire with the bolt open. (See Drawing 1A)

Step 2. PUT “ON” TRIGGER SAFETY

The bolt must **FIRST** be opened, then the trigger safety is pushed from the left to right so that **NO** red is showing (See Drawing No. 1B). It is a good practice to get into the habit of always keeping the trigger safety “ON” until actually ready to fire the gun.

Step 3. PUMP (ONCE)

IMPORTANT: Do not pump over one time. This gun is designed to produce a maximum velocity using a single pump stroke. Additional pump strokes may result in serious damage to the gun. The bolt must be opened to pump gun. For greater safety, we recommend that the bolt remain open while pumping and that you close the bolt only when the barrel can be pointed in a safe direction.

Grasp the pump handle. Pull out and forward as far as possible. You should hear a fresh charge of air being drawn into the pump cylinder. Then, return the pump lever to the original, closed position. (See drawing 2)

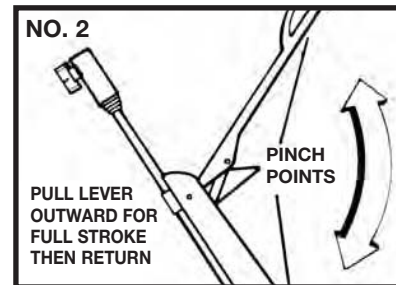

⚠ CAUTION: Be sure to grasp pump handle firmly as you close the lever to prevent it from snapping back and causing possible injury. Also be careful to keep fingers out of cocking mechanism when closing lever. (See “PINCH POINTS,” Drawing No. 2).

⚠ WARNING: Do not open the bolt, close the bolt, and then pull the trigger before pumping. This procedure can result in a **loaded gun** and a projectile being expelled from the gun during pumping. Recock the gun by opening the bolt and put “ON” trigger safety before pumping as in Steps 1 and 2.

CAUTION: If gun is left unpumped for an extended period of time OR pumped more than once, all of the air may not be expelled when the gun is shot. This could result in a second pellet being shot without the gun having been pumped. Also, leaving your gun pumped for more than one hour could result in damage to your gun.

Step 4. LOAD (Model 853)

LOADING PELLETS: With the bolt back, lower the muzzle slightly and load a pellet, solid end forward (See Drawing No. 3).

Step 4. LOAD (Model 853C)

TO LOAD A PELLET AS A SINGLE SHOT: If the single-shot adapter is not already in place in the receiver, insert it into the clip track from the right-hand side until it is flush with both sides of the receiver. Hold the gun with the barrel in a horizontal position and place a pellet (head or solid end forward) in the loading track that is formed by the single-shot adapter. (See Drawing No. 3A).

NOTE: The single-shot adapter can only be removed from the receiver by pulling it from the right-hand side of the gun.

TO LOAD 5-SHOT CLIP: With solid end forward, insert pellet into clip as shown. (See Drawing No. 3B). Be certain that rear edge of pellet skirt is seated deeply enough to be beyond the ramp at the lower edge of the pellet opening. Repeat until clip is completely filled.

TO LOAD 5-SHOT CLIP INTO THE CLIP TRACK: From the right-hand side of the gun, insert a previously loaded clip into the clip track until the left end of the clip is flush with the left side of the receiver (See Drawing No. 3C).

NOTE: The clip may be removed from either side of the gun.

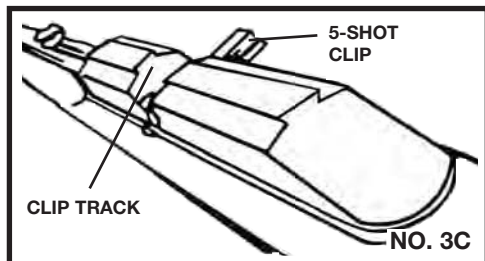
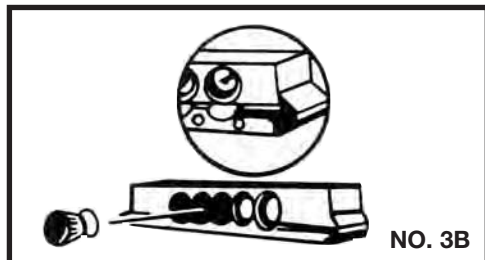
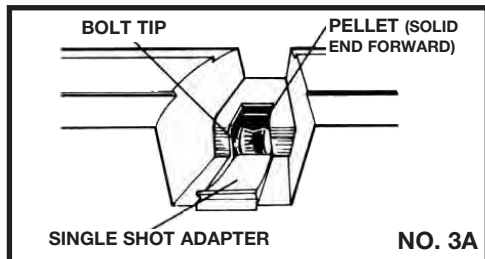
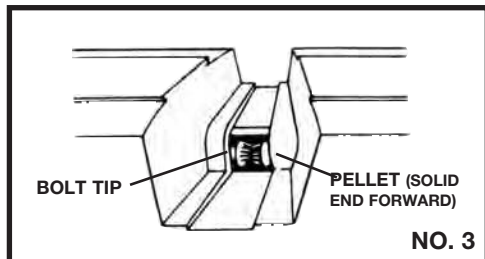

Step 5. CLOSE BOLT

Push the bolt handle fully forward. This will chamber a pellet and lock the bolt. (See Drawing No. 4) The gun will not fire if the bolt is open.

CAUTION: The gun is now loaded and ready to fire.

Step 6. AIM AT SAFE TARGET

Aim the gun at a safe target. To be a consistent marksman, use the correct sight picture each time you fire your gun (See Drawing No. 5). Never point a gun, loaded or unloaded, at anyone.

CAUTION: Use extra caution in selecting a safe target and backstop. This gun should not be used with BB gun targets or backstops. Whether you use a commercial target and backstop or make your own, it is important to remember that they will wear out with continued use. Because of this you should always place your target and backstop where it will be safe should it fail, and check it carefully before and after each use. Do not shoot at the surface of water.

Step 7. TAKE "OFF" TRIGGER SAFETY

When you are certain the target, backstop and surrounding area is safe, push the trigger safety from the right, fully to the left (RED SHOWING ON LEFT). Your gun is now cocked and ready to shoot. In this condition, it should be handled with extreme care.

Step 8. FIRE

After making sure the gun is pointed in a safe direction, gently (but firmly) squeeze the trigger. Repeat Steps 1 through 8 to continue shooting, using the appropriate loading procedure. NOTE: To fire, bolt must be completely closed as indicated in Step 5.

WARNING: If a pellet does not fire after completing the operation steps, the gun is jammed. This is a dangerous condition.

Open the bolt and put "ON" trigger safety immediately. If the bolt is not completely closed, do not try to close it until after opening it by pulling the bolt handle all the way back. The gun will not fire a projectile when the bolt is completely open.

Keep the gun pointed in a safe direction and perform the following steps.

1. Open bolt.
2. Put trigger safety "ON".
3. Pump the gun, close bolt and with gun pointed in a safe direction, take the trigger safety "OFF" and fire the gun.

If the pellet still does not fire, follow these steps carefully:

1. Open bolt
2. Put the trigger safety "ON" (no red showing)
3. Clear barrel by running a cleaning rod through from the muzzle end. Be careful not to damage the bolt tip by pushing the rod through too hard. Do not re-use the pellet.
4. Repeat operation steps 1 through 8. If after following the firing procedure the projectile is not fired, return your gun to Daisy (See "REPAIR OF DAISY GUNS" section).

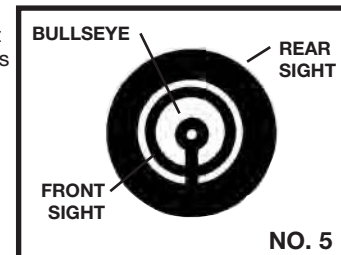
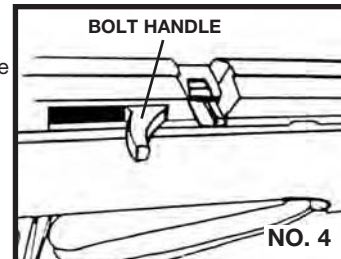

UNLOAD PELLETS:

The bolt does not extract a pellet. You must shoot the pellet out if a safe target is available. If a safe target is not available, put trigger safety "ON" (no red showing), open bolt, insert a cleaning rod in the muzzle end and push the pellet out of the barrel. Invert the gun so that the pellet can fall out of the feed track. Be careful not to damage the bolt tip by pushing the rod through too hard. Do not reuse the pellet.

WARNING: Never assume gun is empty of projectiles. Always point the gun in a safe direction.

AMMUNITION:

Use only .177 caliber (4.5mm) lead air gun pellets. Daisy No. 557 match pellets are excellent for practice and competition. Serious competitors may choose AVANTI No. 357 Competition Diablo match target pellets. These pellets are uniform in size with minimal weight variations. The flat wad-cutting designed head will punch a clean hole to provide for easier and more accurate scoring. AVANTI pellets are engineered to produce maximum accuracy in the Avanti Legend, model 853 and the Avanti Legend EX, model 853C Competition Pellet Rifles.

REAR SIGHT INSTALLATION AND ADJUSTMENT

This is a universal target sight with a rubber eyepiece, which prevents light reflecting from the sight into your eye.

Installation: Mounting is accomplished on the dovetailed receiver of the Avanti Legend model 853 and Avanti Legend EX model 853C Competition Pellet Rifle by loosening the mounting screws and sliding the sight onto the dovetail grooves of the receiver. Position sight where you want it in relation to your eyesight and/or physique. Tighten mounting screws securely.

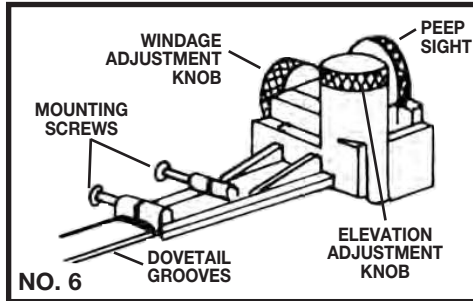

ELEVATION: To lower the point of impact, turn elevation knob to the left (counterclockwise). To raise the point of impact, turn elevation knob to the right (clockwise), per arrow and word "UP" (See drawing No. 7)

WINDAGE: To move the point of impact to the left, turn the windage knob counterclockwise. To move the point of impact to the right, turn the windage knob clockwise, per arrow and letter "R"

Note: This precision peep sight is fully adjustable. Each click of the micrometer adjustment results in a .413 minute of angle (.048 inch) shift of pellet impact at 10 meters (33 feet).

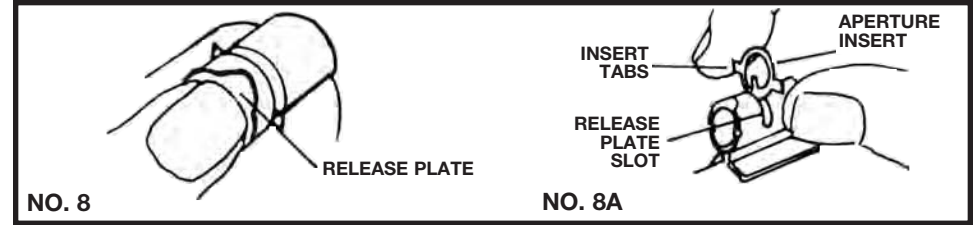
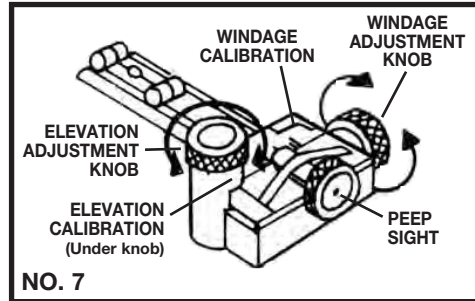

FRONT SIGHT APERTURE INSERTS: Your Avanti Legend, model 853 and Avanti Legend EX, model 853C Competition Pellet Rifle comes with four aperture inserts, with one already in place. To change inserts, follow this procedure:

1. Point the muzzle up and away from you.
2. Using your index finger (or middle and index fingers if your fingers are slender), push in on the top and bottom of the release plate (See drawing 8)
3. With insert release plate pushed in, lift out the aperture insert with thumb and index finger of opposite hand (See drawing 8A).
4. To replace aperture, depress release plate. Place desired aperture in position with insert tabs in appropriate slots (See drawing 8A)
5. Front sight apertures provided with this airgun measure: 3.6mm (.1418 inch), 3.8mm (.1496 inch), 4.0mm (.1575 inch), and 4.2mm (.1654 inch). Post front sight width measures 1.7526mm (.069 inch).

SLING ATTACHMENT

The sling is attached to the Avanti Legend, model 853 and Avanti Legend EX, model 853C Competition Pellet Rifle by a detachable sling swivel which connects to a sling bracket on the forward end of the cocking lever. With the sling attached to the swivel and then pulled back along the underside of the rifle, the tab end of the sling should be hanging down (See drawing No. 9).

PUTTING SLING ON ARM

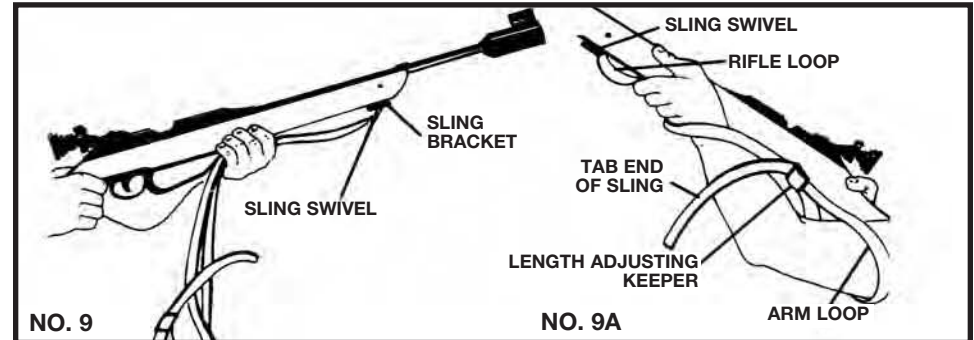

1. Open the arm loop.
2. Turn loop one quarter turn in the direction of the sling arm (i.e., one quarter turn to the left if the sling is going on the left arm) and slip your arm into the loop (See Drawing 9A).

- Place sling loop on your upper arm either above the bicep near the shoulder or below the bicep.
- Tighten the sling loop until it is snug enough to remain in place on your arm. It should not be so tight that it restricts the flow of blood in your arm or creates a pulse effect.

LENGTHENING SLING: Grasp the tab end of the keeper with your trigger hand and lift it up while pulling on the top strand (not the tab end) of the sling (See drawing No. 9B).

SHORTING SLING: Pull the tab end of the sling away from you until sling reaches the desired length (See drawing 9C).

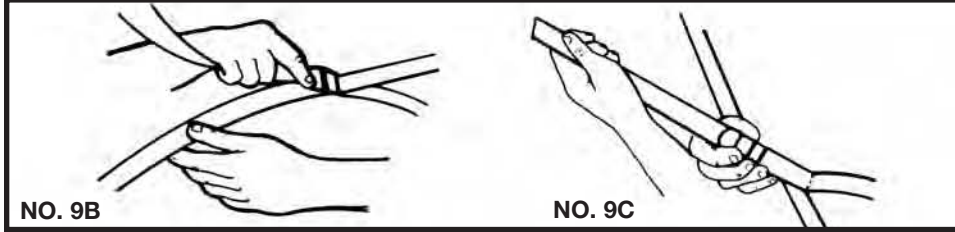

STOCK ADJUSTMENT

To adjust the stock, loosen screws in buttplate sufficiently to allow insertion of the desired number of spacers (See drawing No. 10). Spacers go between stock and buttplate. Each insert will adjust stock length 5/8 inch (.625 inch). After stock adjustment inserts have been added, tighten buttplate screws to lock inserts in place. To shorten the stock, reverse this procedure. Be certain spacers are placed so the molded cleats nest in the molded receptacle.

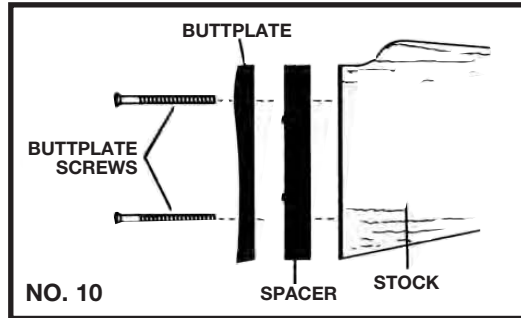

PROPER CARE

With care, periodic cleaning and lubrication, your Avanti Legend, model 853 and Avanti Legend EX, model 853C, Competition Pellet Rifle will provide many years of shooting enjoyment. As is the case with conventional firearms, abuse, neglect and continued exposure to the elements will impair the performance. Learn to take care of your Avanti Legend, model 853 and Avanti Legend EX, model 853C, Competition Pellet Rifle and it will serve you well.

CAUTION: Never attempt to clean the Avanti Legend, model 853 and Avanti Legend EX, model 853C, Competition Pellet Rifle until you put the trigger safety in the "ON" position (no red showing), have made absolutely certain that the gun is not loaded and have the bolt in the fully open position.

STOCK AND FOREARM: The wooden stock may be wiped clean with a damp rag, and lightly waxed.

EXTERIOR PARTS: Exposed metal parts (i.e., receiver, barrel, etc.) should occasionally be wiped clean using a soft, lightly oiled cloth. Use a clean motor oil.

BARREL: The barrel should be cleaned occasionally to maintain accuracy. We recommend using Daisy's No. 5875 Cleaning Kit. To clean the barrel, open bolt and insert cleaning rod and oil saturated patches into the muzzle-end of the bore. Retract the rod and patch from the barrel. Repeat this procedure several times with oiled patches, then switch to dry patches. Continue using dry patches until most of the oil is removed from the bore.

NOTE: Be careful not to damage the sealing tip on the bolt when the cleaning rod tip enters the loading area. It may be necessary to clean the barrel approximately every 50 shots to maintain maximum accuracy. Frequent cleaning may be necessary when the gun is new, and until excess oil is removed from the pump system.

LUBRICATION

Your Avanti Legend, model 853 and Avanti Legend EX, model 853C Competition Pellet Rifle should be lubricated approximately every 1000 shots. Lubricate the pump piston foam wiper ring by inverting the gun and opening the lever fully. You will see "Oil Here." Oil the felt wiper which can be seen through a slot in the pump tube. Add oil, drop-by-drop, until the wiper appears saturated.

The pump lever pivot joints should be lubricated sparingly by adding one or two drops of oil to each pivot pin (See Drawing No. 11).

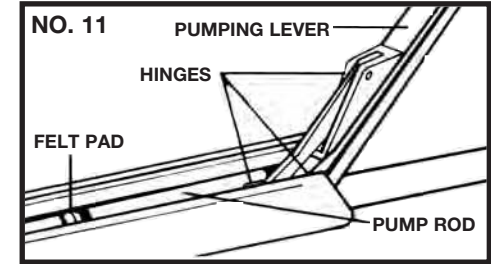

STORAGE

To make your Avanti Legend, model 853 and Avanti Legend EX, model 853C, Competition Pellet Rifle safe for storage or transporting, proceed through operating steps 1 through 8, omitting Step 4 (Loading), **WHILE POINTING THE GUN IN A SAFE DIRECTION WHEN YOU GO THROUGH THESE STEPS!** Then put the trigger safety "ON" (no red showing). This will ensure that the hammer is fired, that no air is stored in the pump system, that there is not a pellet in the chamber and that the trigger safety is "ON".

Always store pellets in a place separate from the gun to keep them from untrained shooters. Before putting your gun away, make sure it is clean, dry, oiled, unloaded and uncocked. If the gun is to be stored for a long period of time, a light coat of oil in the barrel will help prevent corrosion.

MODIFICATION

WARNING: The components of this gun were engineered to deliver optimum performance. Any modification or tampering with a gun may cause a malfunction and may make it unsafe to use. Any change in performance, such as a lowered trigger force and shortened trigger travel, indicates possible wear. In such cases, qualified personnel should inspect and, if necessary, repair or replace the gun. Any gun that has been dropped should be checked by qualified personnel to insure that its function has not been effected.

WARNING: A GUN THAT IS NOT OPERATING PROPERLY MAY BE DANGEROUS. IT SHOULD BE KEPT SAFELY FROM USE BY ANYONE UNTIL REPAIRED OR DESTROYED. DO NOT TRY TO TAKE THE GUN APART. IT IS DIFFICULT TO REASSEMBLE, AND IMPROPER REASSEMBLY CAN CAUSE A HAZARDOUS CONDITION.

GUNS IN WARRANTY LIMITED ONE-YEAR WARRANTY

For one year from date of purchase, Daisy will repair or replace and return this gun, free of charge, if defective in material or workmanship. Service is available by returning the gun to Daisy Outdoor Products (refer to important note below). Attach to the gun, your name, address, and telephone number, description of problem and proof of date of retail purchase (sales slip). Package and send transportation prepaid to Daisy. This Warranty gives you specific legal rights, and you may also have other rights which may vary from state to state.

IMPORTANT: You can return your inoperative rifle to Daisy for repair via United Parcel Service. Be sure to put "ON" safety and unload all ammo before returning the gun to Daisy. You must include your street address for Daisy to send your rifle directly back to you through UPS delivery.

GUNS OUT OF WARRANTY

If your PowerLine® gun needs repair, please call 1-800-713-2479 for repair charges. Daisy will repair the gun or replace it with a reconditioned gun of the same model, if available; otherwise, with a model of equivalent quality.

Daisy Outdoor Products
Service Department
308 West Stribling Drive
Rogers, AR 72756 U.S.A.

SPECIFICATIONS LEGEND – 853 / LEGEND EX - 853C

ACTION	Single pump pneumatic with straight pull bolt action
MAGAZINE - 853 - 853C	Single shot pellet 5-shot auto indexing clip
CALIBER	.177 cal. (4.5 mm)
AMMUNITION	.177 cal (4.5 mm) lead air gun pellets
FRONT SIGHT	Globe sight with changeable aperture inserts
REAR SIGHT	Peep sight with micrometer click, screw adjustment
BARREL	20.9 in. high-grade Lothar Walther™ barrel; rifled steel with 12 lands and grooves, right-hand twist. Precision bored for match pellets
MUZZLE VELOCITY	853 - 510 fps, 155 mps; 853C - 490 fps, 149 mps
MUZZLE ENERGY	4.5 ft lb. (6.0J)
TARGET DISTANCE	33 ft. (10m)
MAXIMUM SHOOTING DISTANCE	853 - 257 yds. (235 m) with muzzle pointed at optimum angle 853C - 252 yds. (230 m) with muzzle pointed at optimum angle
ADD-ON ACCESSORIES	Standard dovetail mount on receiver to accept scope. Nylon web sling
STOCK	Sporter style with adjustable buttplate for trigger pull length.

PARTS ORDERING

It is highly recommended that only genuine Avanti parts are used in this rifle. The use of non-genuine parts will invalidate your warranty.

If your rifle needs repair parts, please call 1-800-713-2479 for repair part charges. **Have the Model Number of your rifle as well as the Part Number needed at hand before calling.**

PARTS LIST

KEY	PART NO.	DESCRIPTION
1	853-1	"O" Ring & Valve Group
2	853-2	Band - Barrel
3	5899	Sight, Rear Adjustable Peep
4	853-4	Bracket - Sling
5	853-5	Sling Assembly
6*	853-6	Receiver 853
7	853-7	Screw Assortment (Includes 7,9,10,12, 34, 35, 36, 37, 38)
8*	853-8	Stock (Includes Butt Plate)
9	853-9	Pin Lever (Included in 7)
10	853-10	Screws, Stock (Included in 7)
11	853-11	Sight, Front (Includes set screws)
12	853-12	Screws - Valve Body ((2) Included in 7)
13	853-13	Housing, Trigger
14*	853-14	Pump Lever Assembly
15	853-15	Frame
16	853-16	Tube Pump
17*	853-17	Valve Body & Barrel Assembly
18	853-18	Lock, Trigger (Included in 20)
19*	853-19	Sear (Included in 20)
20	853-20	Trigger Assembly (Includes 18,19, 20, 22, 23)
21	853-21	Spring, Hammer (Included in 28)
22	853-22	Spring, Bolt & Sear (Included in 20 & 30)
23	853-23	Spring, Trigger (Included in 20)
24	853-24	Spring, Latch (Included in 29)
25	853-25	Spring, Safety (Included in 27)
26	853-26	Ball Safety (Included in 27)
27	840 SY	Safety Assembly (Includes 25 & 26)
28*	853-28	Hammer (Includes 21)
29	853-29	Latch - Lever (Includes 24)
30*	853-30	Bolt handle Assembly (Includes 22)
31	853-31	Wiper - Pump & "O" Ring (Included in 1)
32*	853-32	Filler - Inletting, Right
33*	853-33	Filler - Inletting, Left
34	853-34	Nut - Stock ((2) Included in 7)
35	853-35	Screw - Valve Body (Included in 7)
36	853-36	Spacer (Included in 7)
37	853-37	Nut - Stock Blox (Included in 7)
38	853-38	Screw - Sear (Included in 7)
39	99Z	Sight Inserts (3)
40	900-12	Actuator, Clip (853C only)
41	900-31	Bar Actuator (853C only)
42	9900	Five-shot Clips (Package of 5 clips - not pictured) (853C only)
43	853-43	Stock Adjustment Insert

* When ordering these parts please specify model 853 or 853C.

